

Nucleic Acids

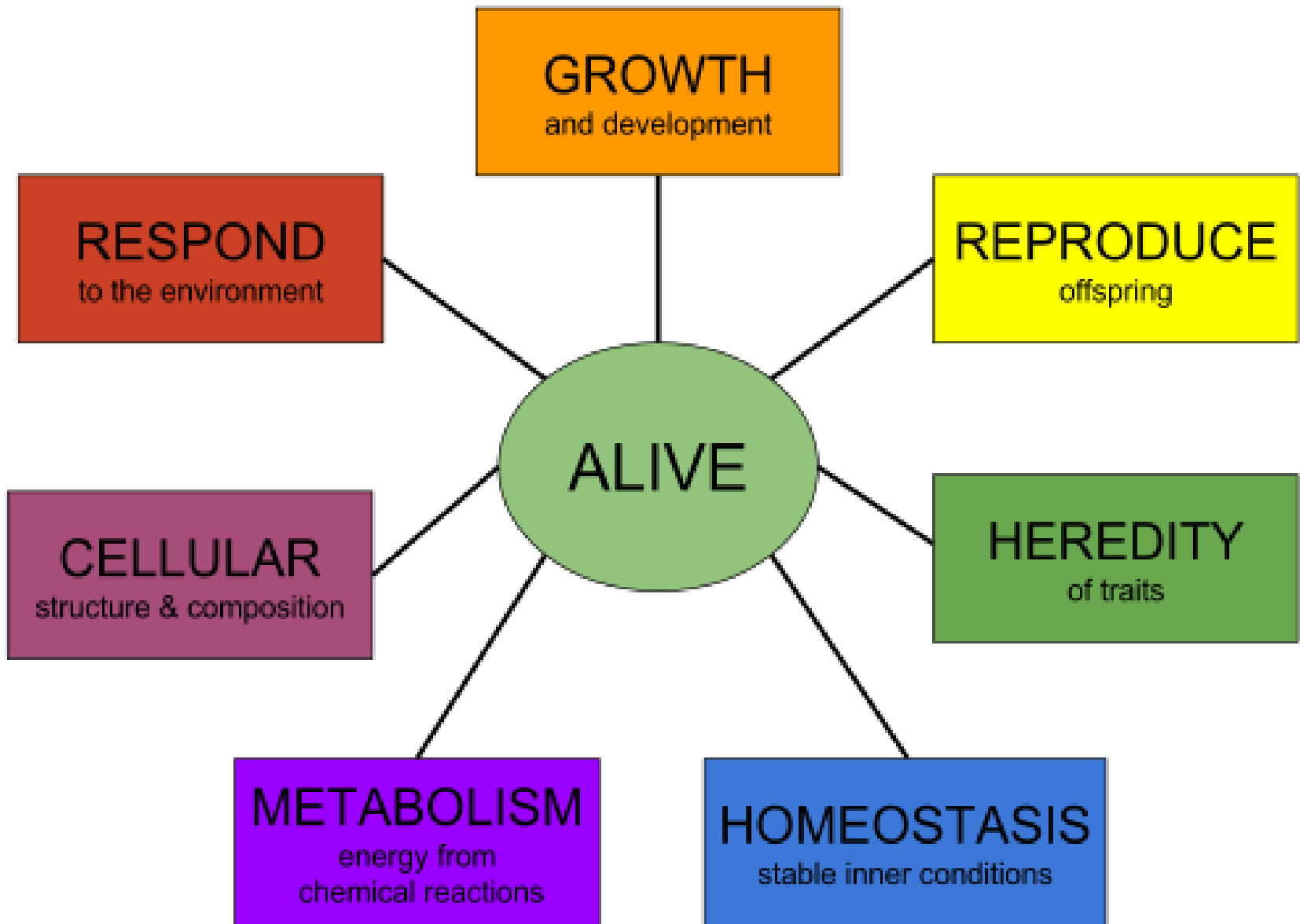

Nucleic acids carry genetic information

- For long time scientists assumed that genetic information is carried by proteins
- In 1944 Avery, MacLeod and McCarty reported experiment showing that DNA was transforming factor in bacteria.

Griffith experiment

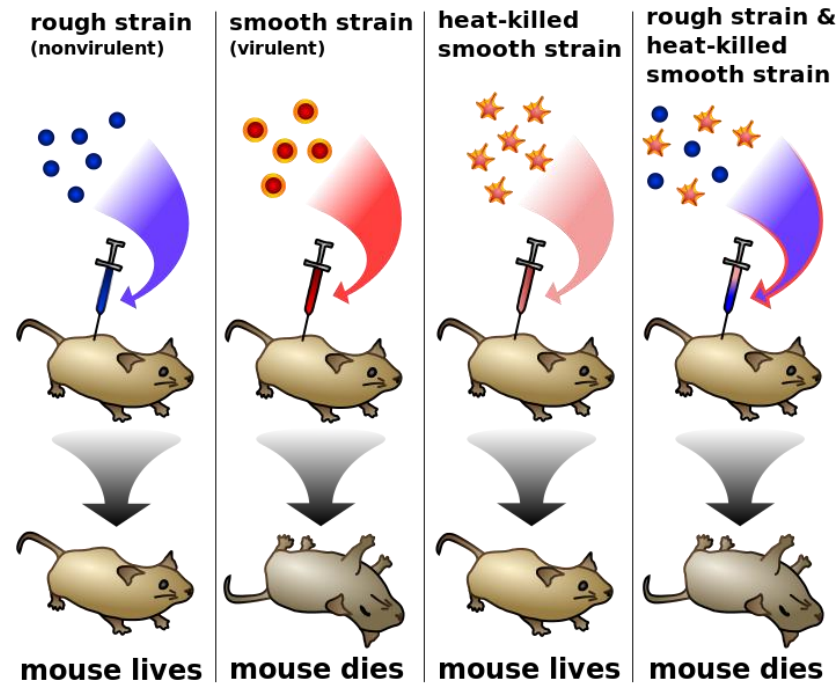

- Griffith experiment indicated that non-pathogenic strain of bacteria could be "transformed" into the lethal strain by a "transforming principle" that was somehow part of the dead pathogenic bacteria.
- Avery, MacLeod and McCarty showed that the "transforming principle" was DNA from the dead bacteria.

Functions of nucleic acids in the cell

- Storage and propagation of genetic information.
- Transcribing and translating of genetic information into protein sequences.
- Structural and catalytic functions.

The Central Dogma of Molecular Biology

- Information is transferred from DNA to RNA to protein

DNA -> RNA -> Protein

- Proteins create traits
- This is called **gene expression**
- This process is found in all organisms

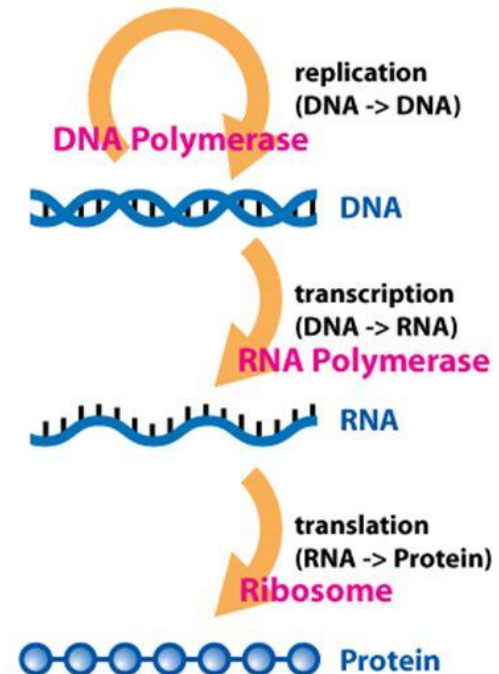

Nucleic acids

3

□ Information flow

- **DNA** → **RNA** → **PROTEIN**
- **DNA:** storage of genetic information
- **RNA:** expression of genetic information
- **PROTEIN:**

Rajesh Chaudhary

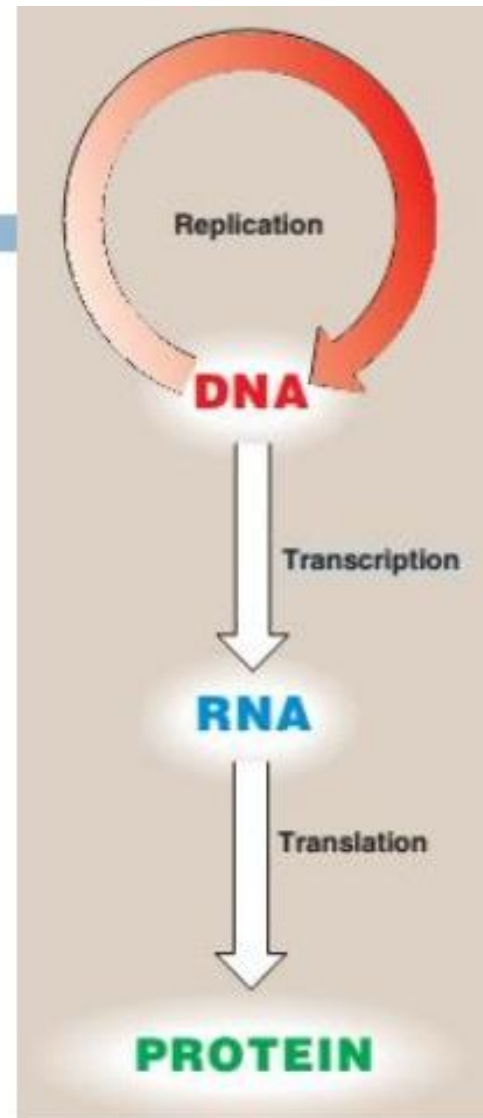

Chemical structure of nucleic acids

- Nucleic acids are biopolymers. They are chains consisting of monomers called nucleotides joined together by phosphodiester bonds

Structure of DNA and RNA

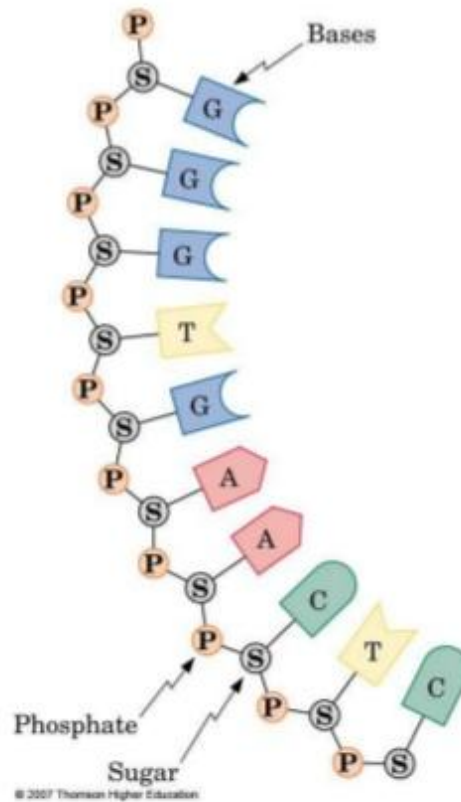

Nucleotides

Basic Nucleotide Structure

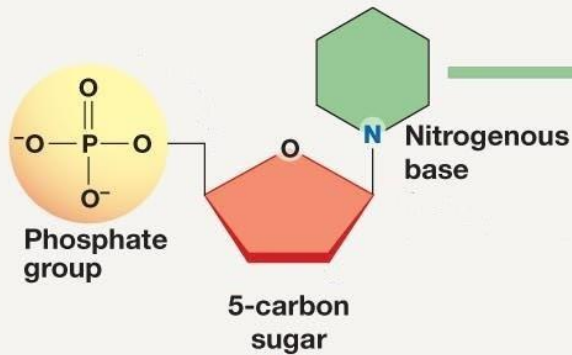

(b) Sugars

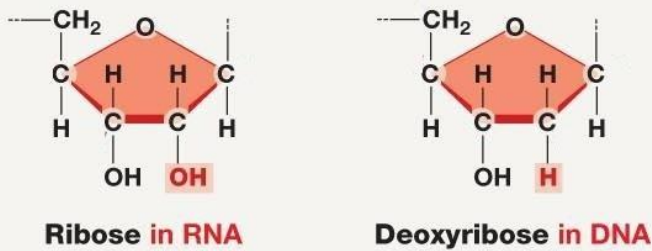

(c) Nitrogenous bases

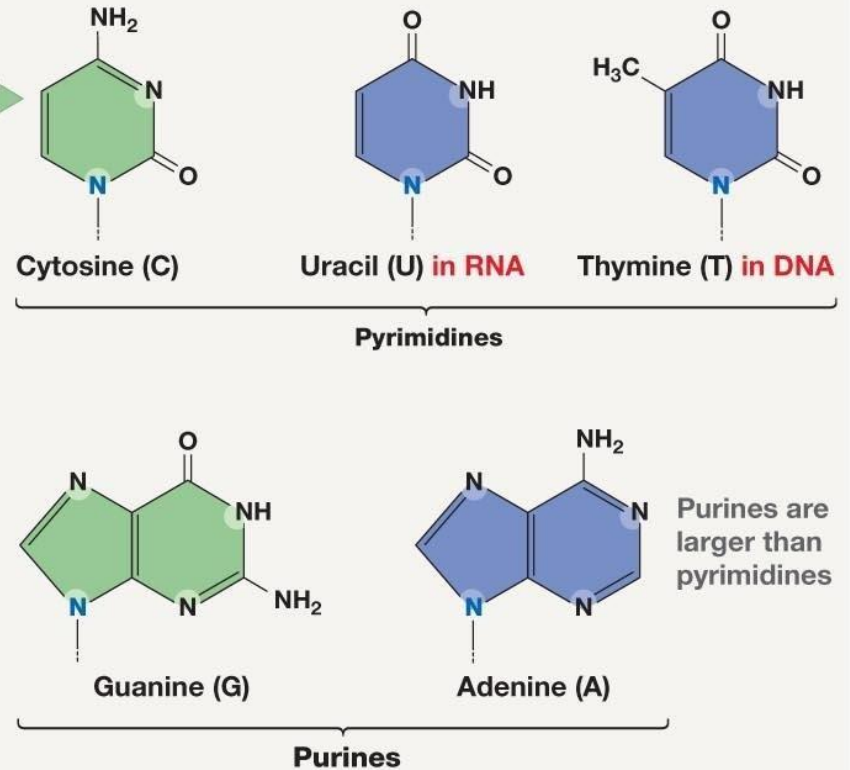

Phosphodiester bond

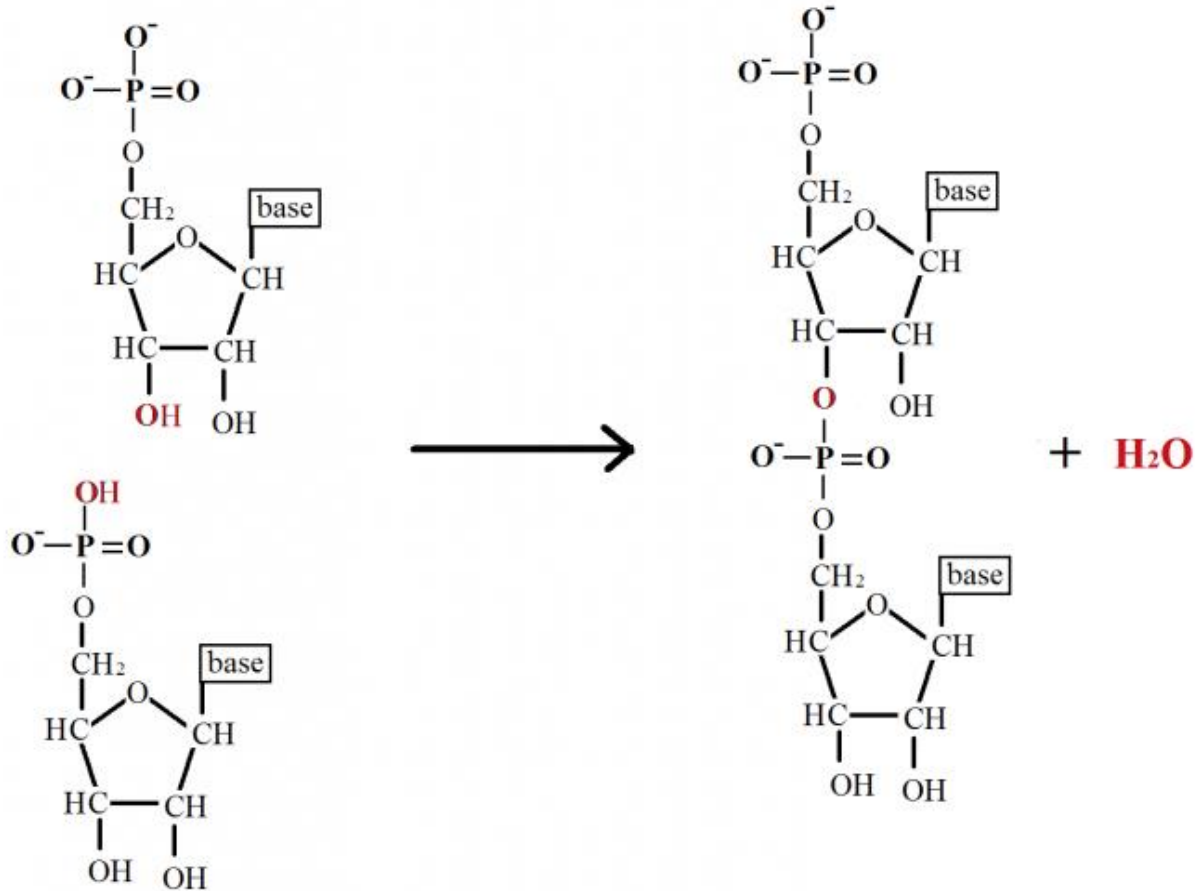

Nucleic acid strand has direction

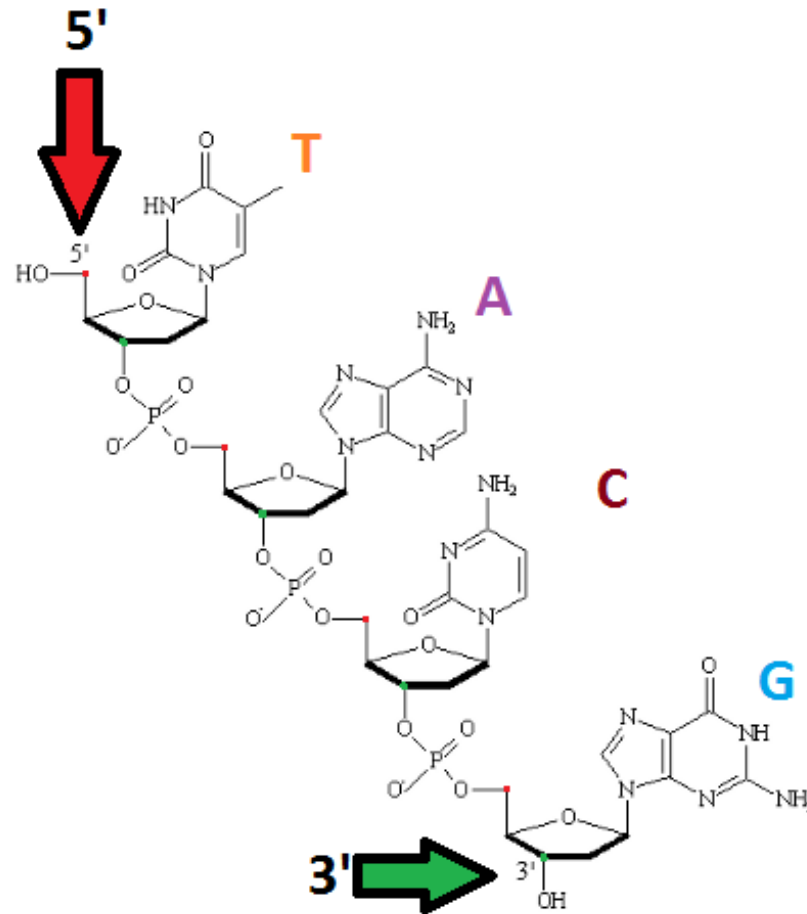

- Nucleic acids have secondary structure. They could be single stranded (ssDNA, ssRNA) or double stranded (dsDNA, dsRNA or DNA-RNA hybrid molecules). Double stranded nucleic acid forms when two single stranded molecules with complementary sequences meet and hydrogen bonds are formed between the bases of the two strands.

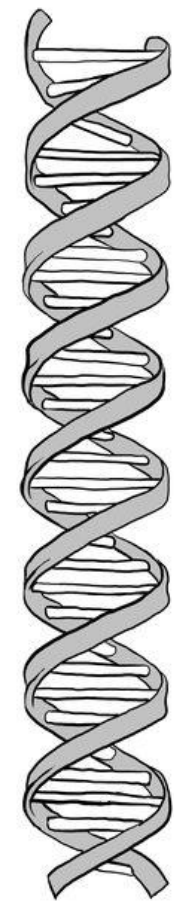
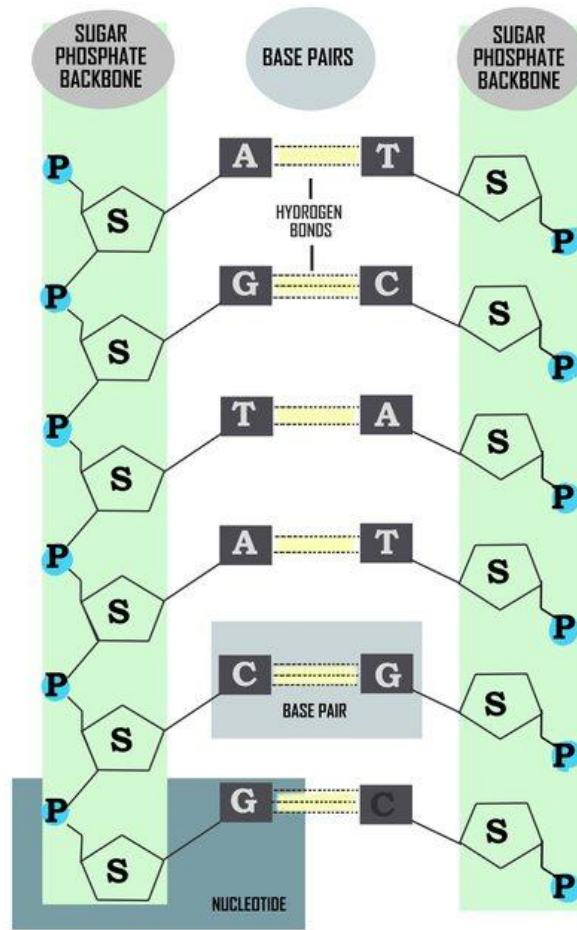

- Nitrogenous bases of nucleotides can form hydrogen bonds with each other:

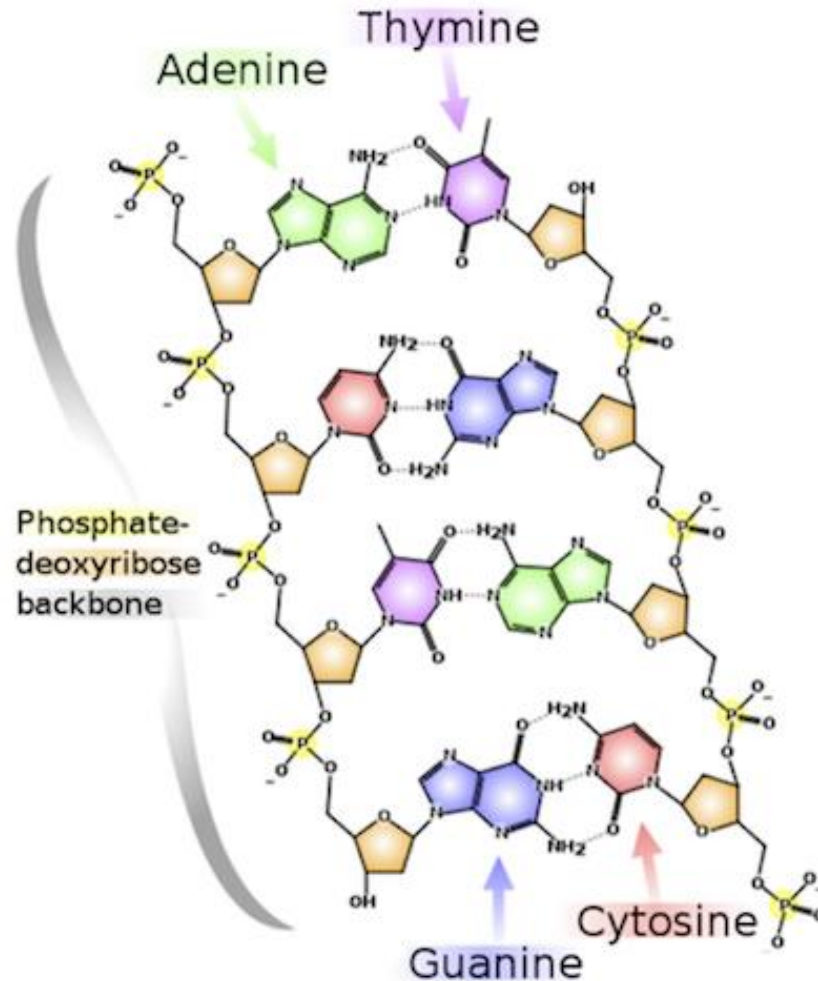

Complementary nucleic acid strands

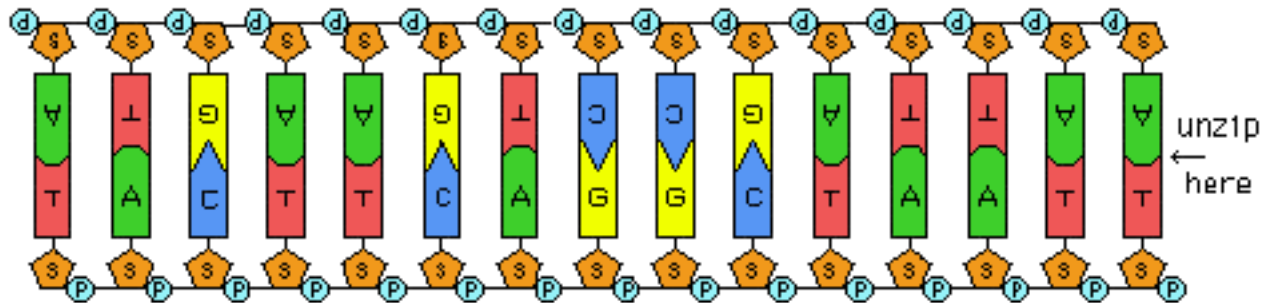

Sometimes ds regions are formed within the same single stranded NA molecule

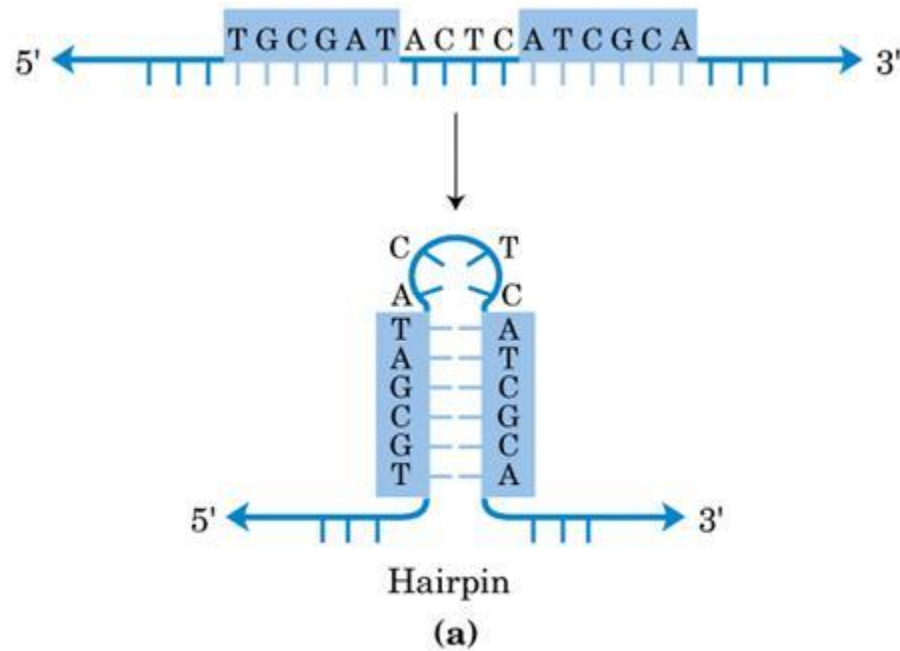

ssNA secondary structure

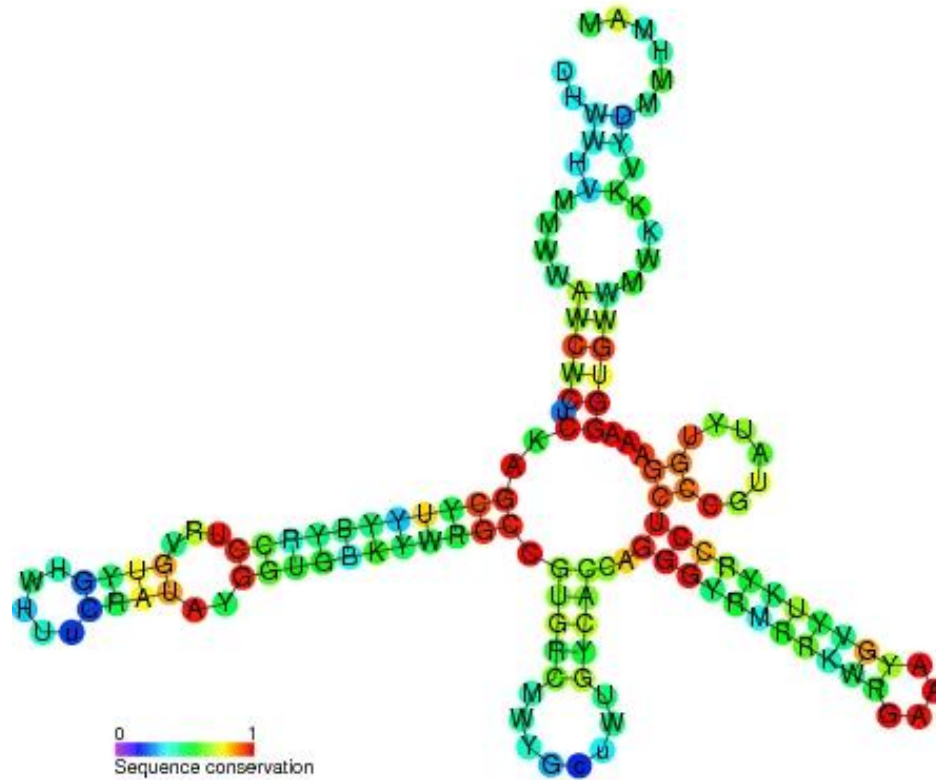

Double stranded NA could be denatured by heat

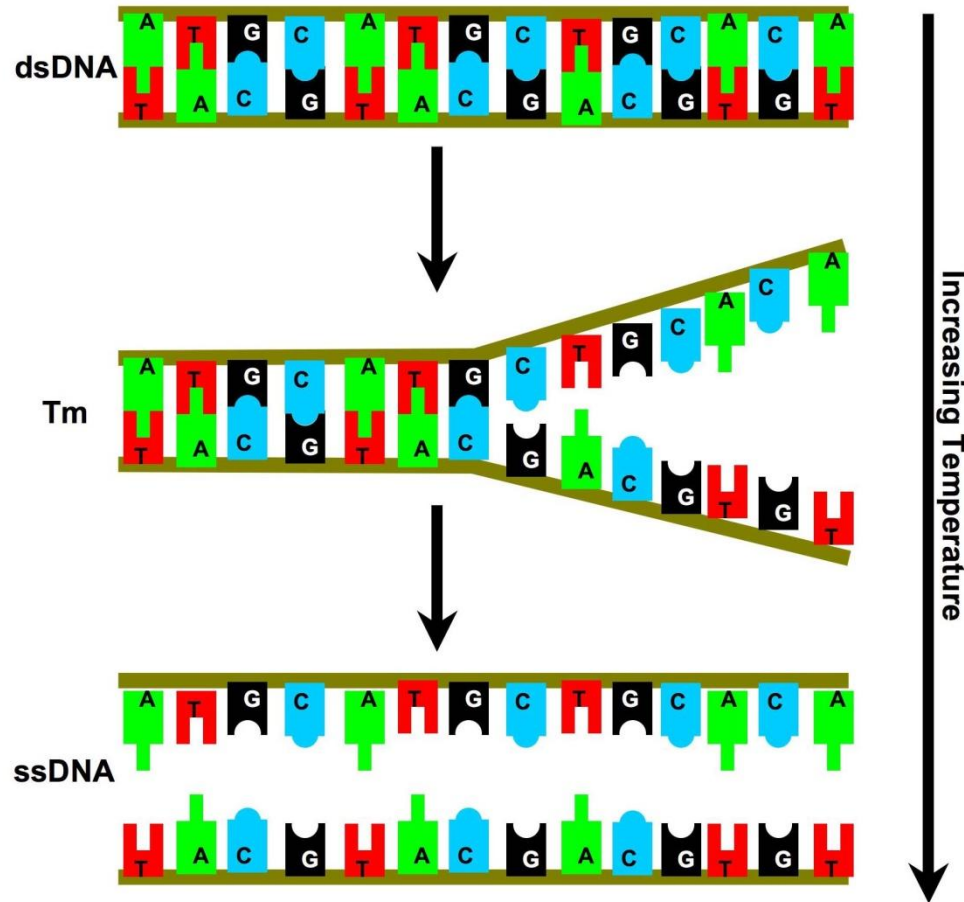

Denaturation of DNA

- ◆ Double helix unwinds when DNA is denatured
- ◆ Can be re-formed with slow cooling and annealing

