

Chemistry - 1

Let's continue the journey
October 23th 2022

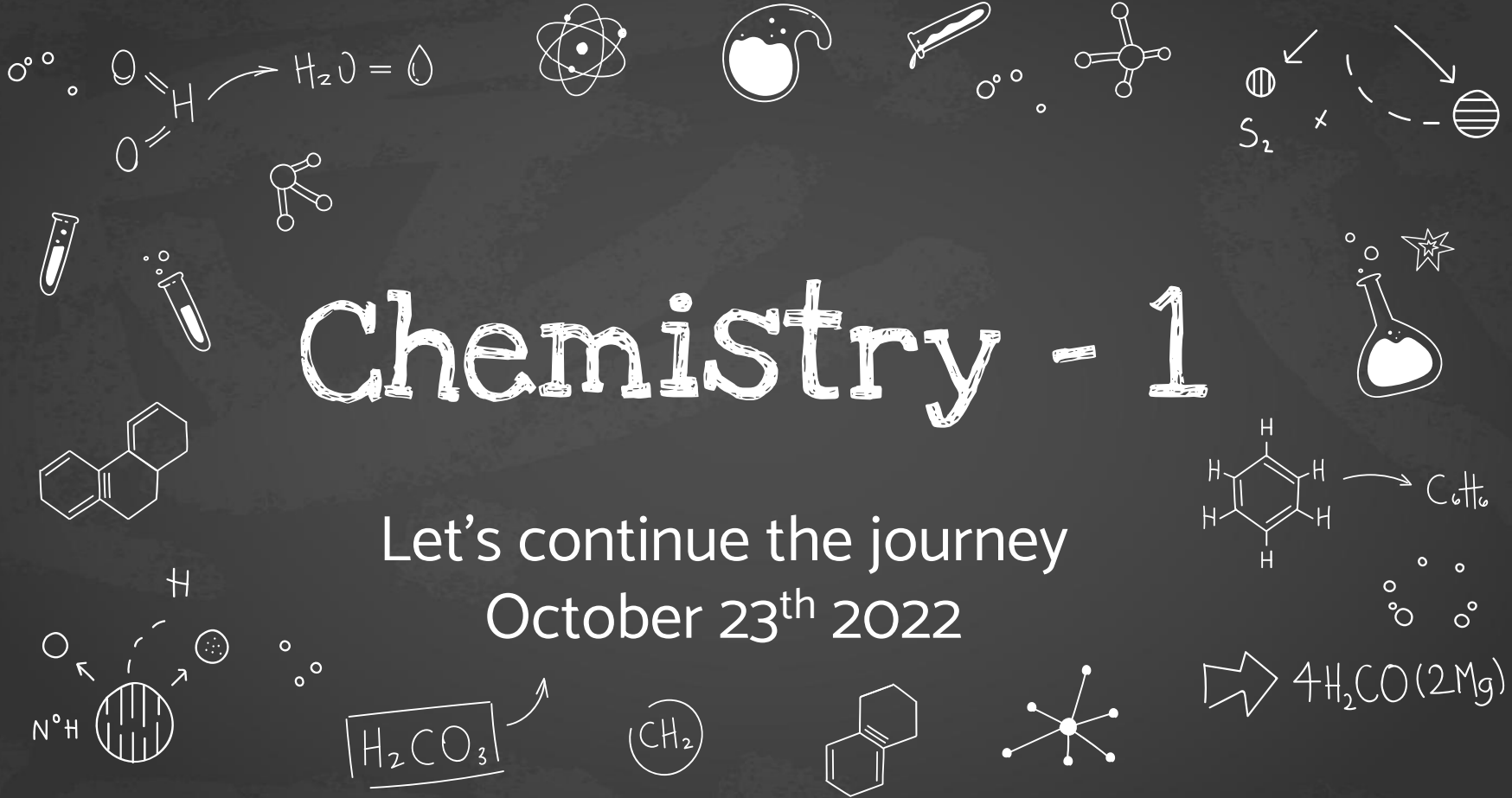

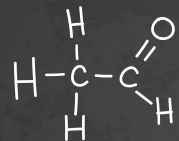
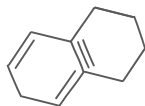

Electrons

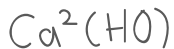

What are electrons?

Where are electrons in the atom?

What role do they play in elemental properties and can they be predicted based on the electron configuration of the atoms?



$$a_{n+1} - a_n = 0_n$$



We will be only talking about MODELS
of the electron shells of atoms

This will help us to explain and
predict many properties of
substances around us

The basis of the atomic structure is
the force of attraction between the
negative electrons and the positive
nucleus. It is governed by

$$\text{Coulomb's law: } F = K (q_1 q_2) / r^2$$

Electrons and protons

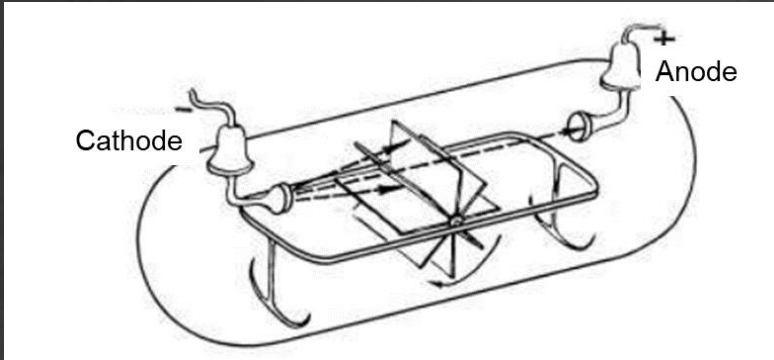

Discharge tube (cathode ray)

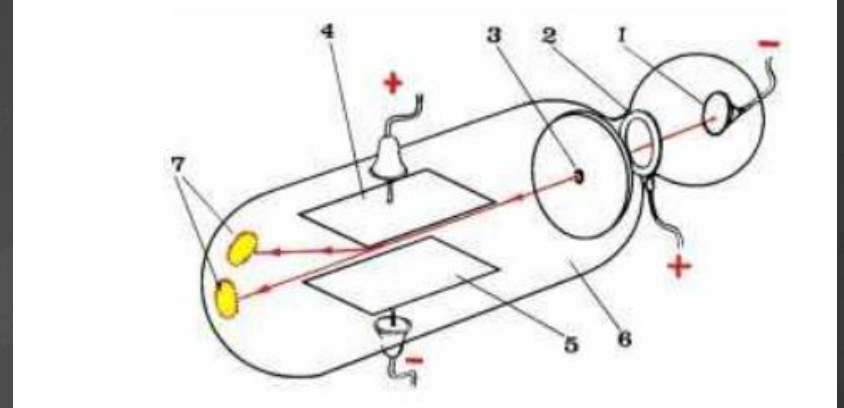

Thomson's cathode ray tube
1 – cathode; 2 – anode; 3 – hole; 4 and 5 – electrodes to bend the rays; 6 – phosphorescent coating, 7 – phosphorescent spots.

Rutherford's experiment

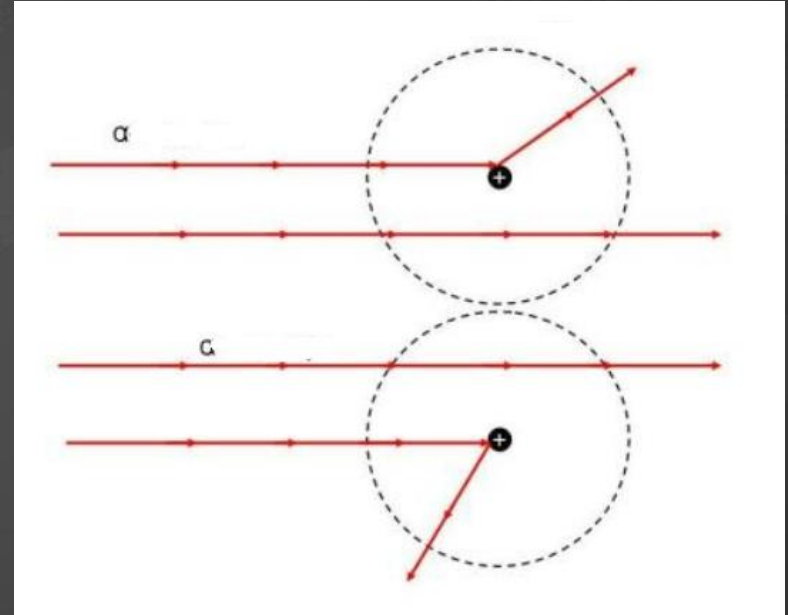
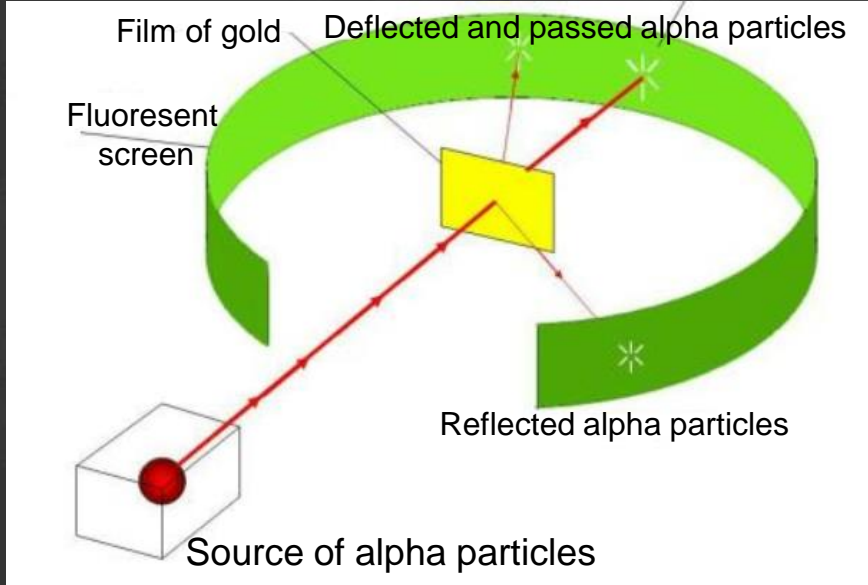

Atomic models

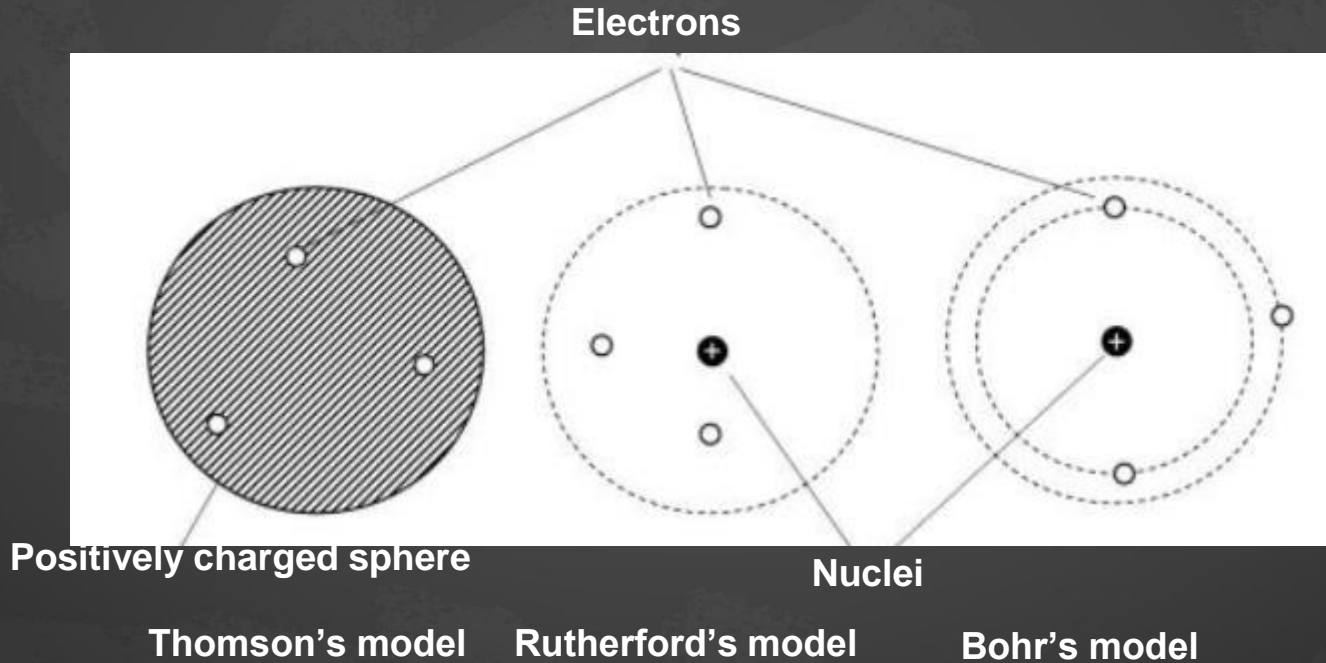

Electrons obey the bizarre rules of quantum mechanics

An electron is both a particle like a marble (it has mass, charge, spin) and a wave (it has a wavelength) as a beam of light

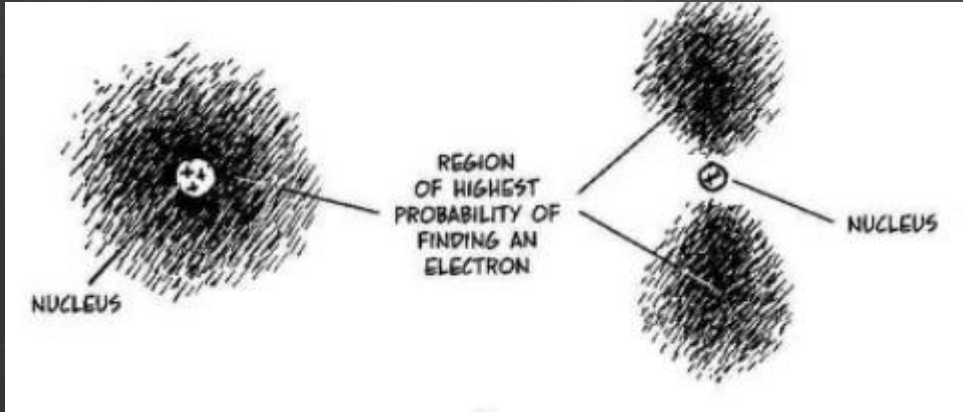
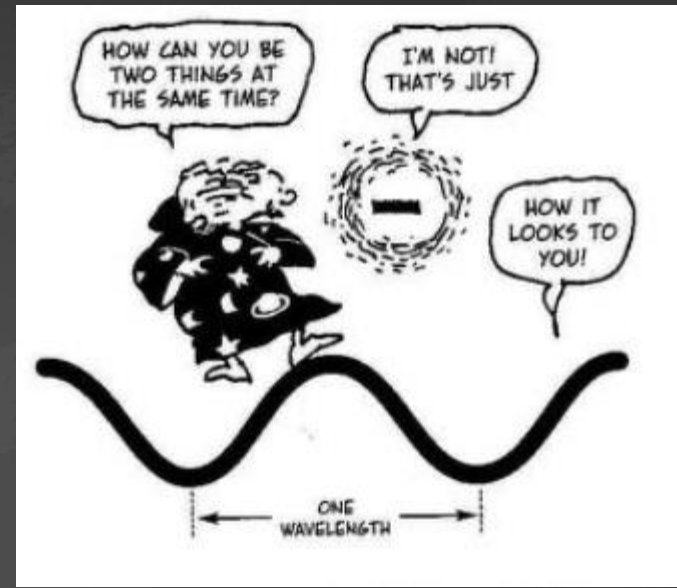

An electron inhabits a "probability cloud" with the densest parts of the cloud being where the electron is likeliest to "be" - if it can be said to be anywhere, which it can't exactly

The Bohr Model is a planetary model in which the negatively charged electrons orbit a small, positively charged nucleus similar to the planets orbiting the sun.

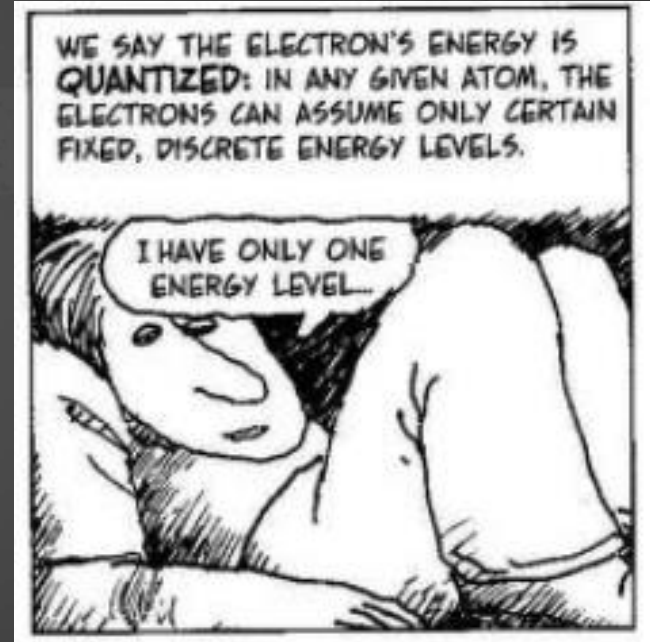
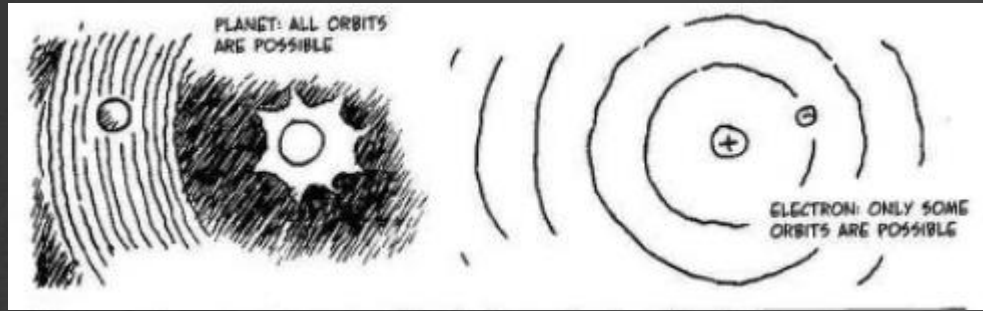

An electron must occupy an orbit around the nucleus that is consistent with the whole number of wavelength - n is a whole number.

The numbering starts from the nucleus.

We will call these orbits "shells". Each shell has a number starting from the nucleus. This number is called principal quantum number.

We can also visualize electron as a wave, beaming around the nucleus. Quantum mechanics tells us that the electron is always a "standing wave" that is it "goes around" the nucleus a whole number of wavelength, but never a fractional value.

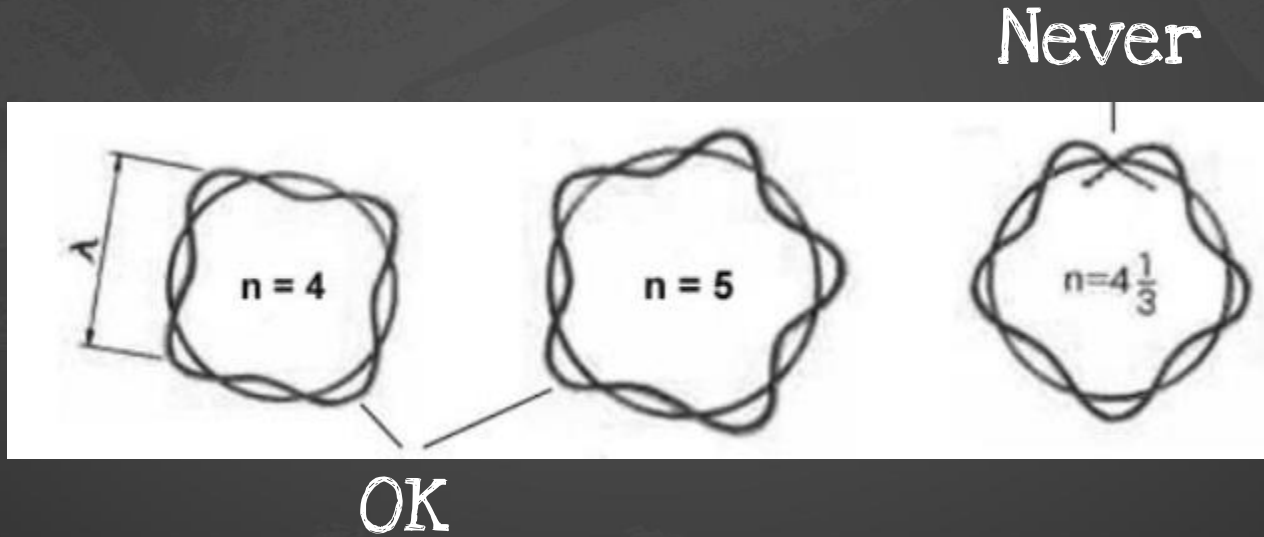

Electron's energy in each shell

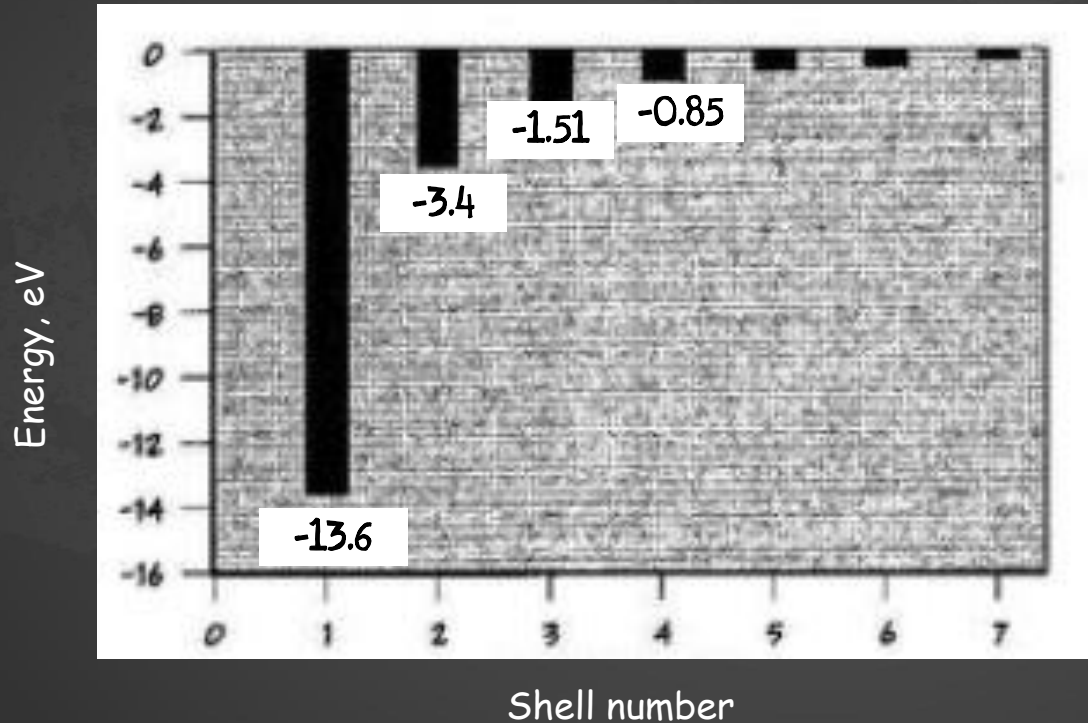

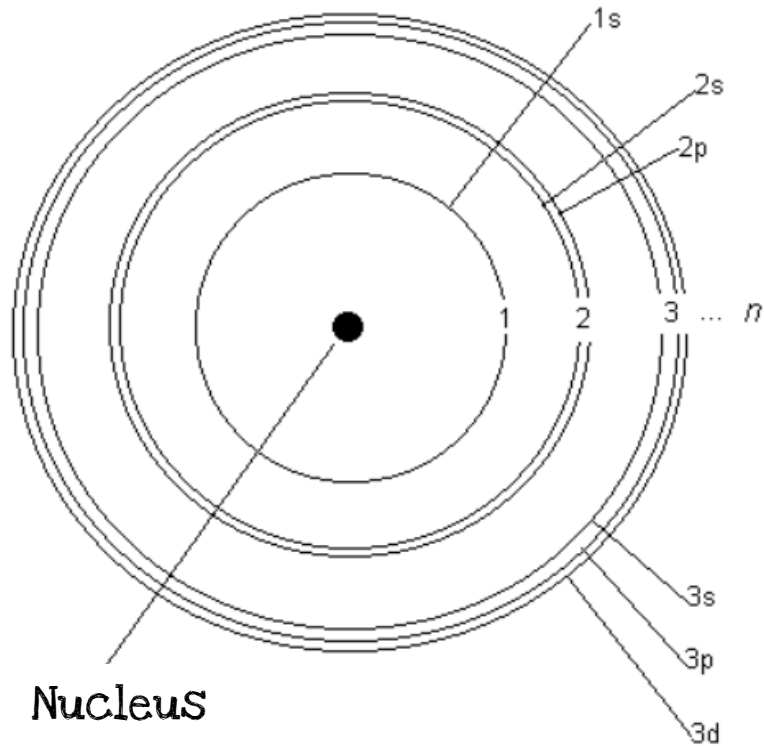

Shells consist of electron configurations that are close in energy and are called "orbitals". You can think of these orbitals as energy sublevels.

Different sublevels are called s, p, d, and f, and each orbital can hold up to two electrons

- The number of electrons is equal to the number of protons.
- Electrons inhabit the closest to the nucleus shells and orbitals.
- Each shell and each orbital can hold just a certain number of electrons.
- **The maximum number of electrons that each shell can have is $2n^2$**

Shells and subshells

- The number of subshells within any level is equal n (the shell number)

Shell number (n)	Sub-shell
1	s
2	s, p
3	s, p, d
4	s, p, d, f

Sub-shell	Number of orbitals	Maximum number of electrons
s	1	2
p	3	6
d	5	10
f	7	14

Electron as a wave - Schrödinger atomic model

- Schrodinger described electron movement in space using mathematical models for a wave
- The model describes probability of finding an electron-wave in a certain point around the nucleus
- There are still orbitals in this model, they represent the space around a nucleus where an electron can be found with the probability of 95%.
- All calculations were done for a single electron

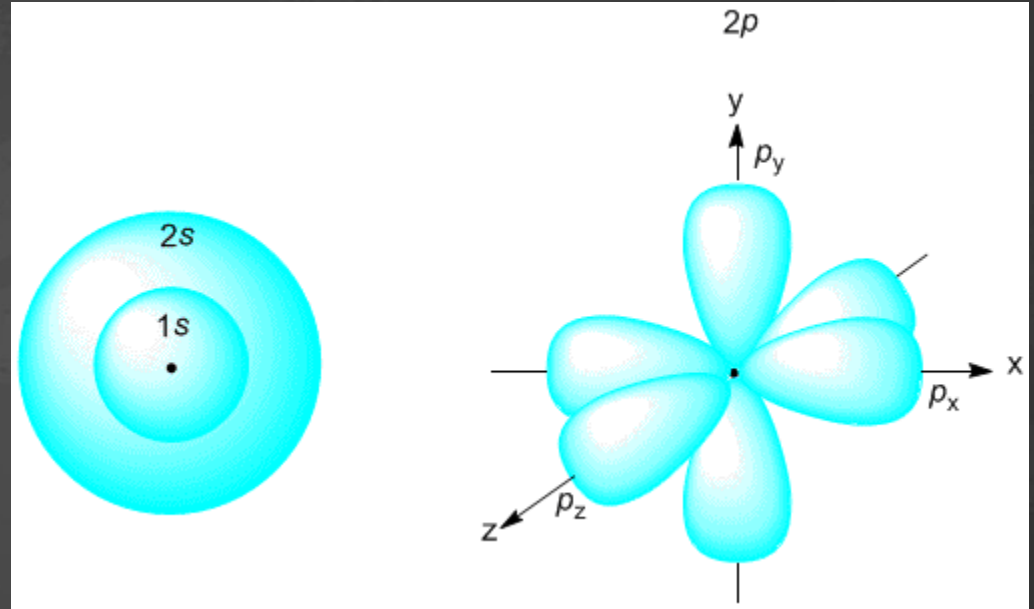

Shell 1

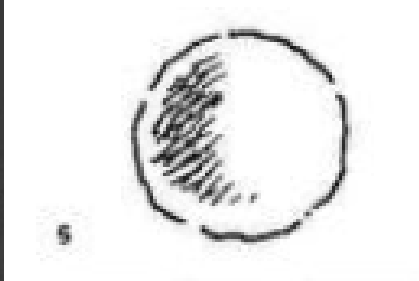

Shell 2

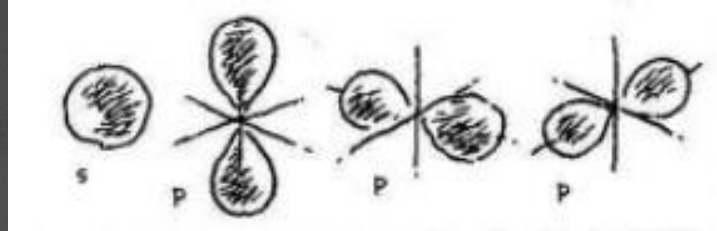

Shell 3

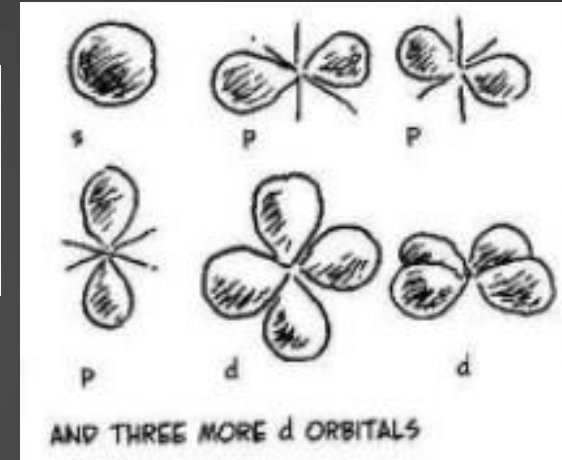

Shell 4

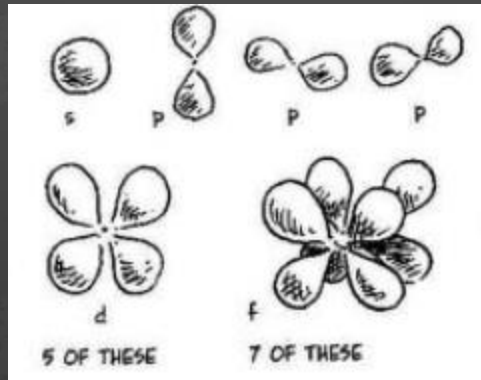

s

p

d

f

•

1



2

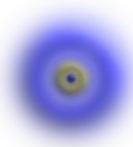

3

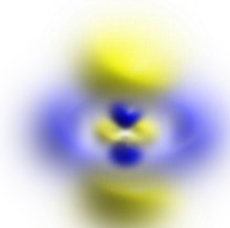
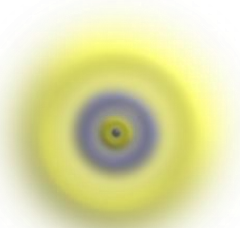

4

This diagram shows the energy levels of different orbitals

Note that shells have overlapping energies: e.g. Some orbitals in shell 4 (4d and 4f) have higher energy than some orbitals in shell 5 (5s)

2s means the s orbital in shell 2, 4d means the d orbital in shell 4 etc.

As we build up an atom each electron "wants" to go into the lowest available energy state. We start at the lowest, then when that fills up, go to the next-lowest, etc.

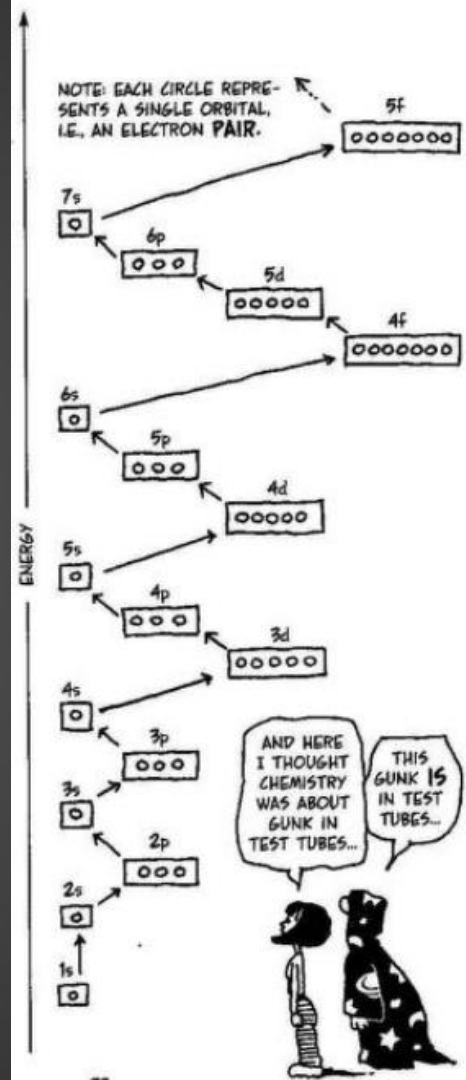

Rules of filling electrons' shells

1. Decide the total number of electrons to be placed (it should be equal to the number of protons, which is its atomic number)
2. Add electrons to each orbital starting with that of the lowest energy level and keeping in mind that we cannot place more than 2 electrons on each orbital
3. According to Hund's rule, all orbitals will be singly occupied before any is doubly occupied.

This will be an atomic electron configuration

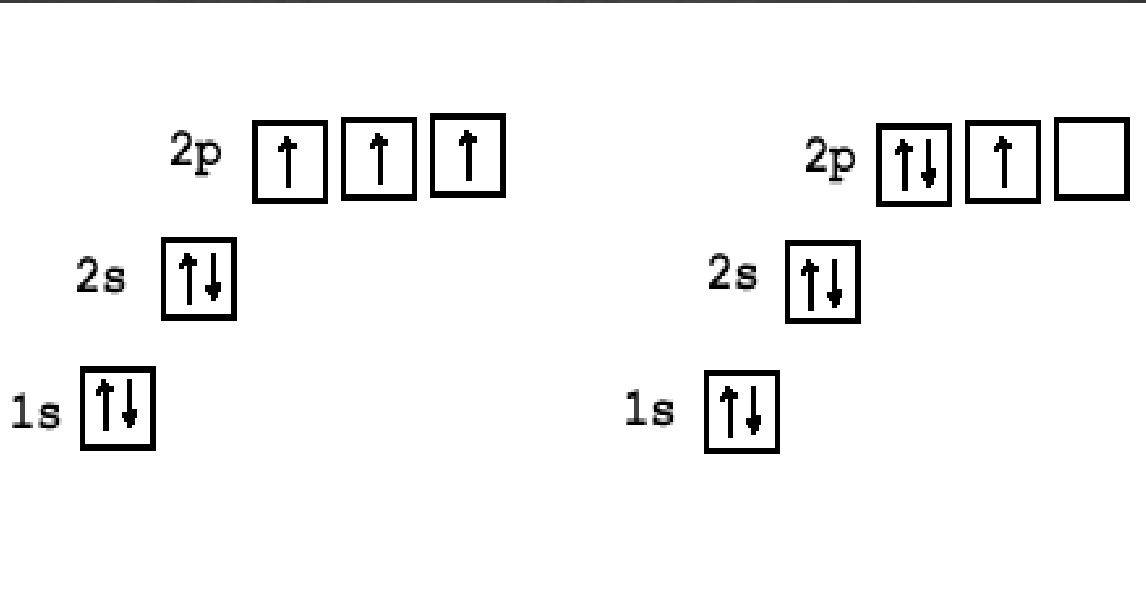

Correct

Incorrect

- Let's write down an atomic electron configuration of element with the atomic number 7